



# Image Recognition Sensor

Operation instructions

# Operation instructions

Make your choice...

## LV801 Image Recognition Sensor

Black



White



### 1 Safety instructions



Thank you very much for purchasing this products, in order to use it correctly, please read this manual carefully before use it.

### 2 Product Overview

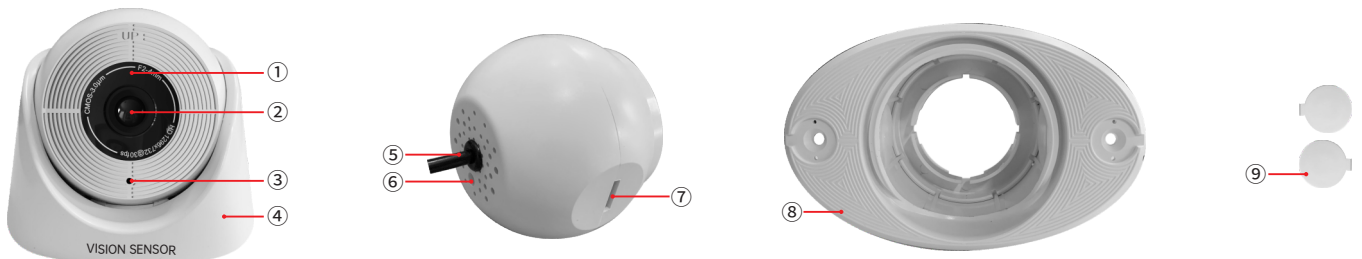

- ① LED indicator: Standby- Blue light, Action-Red light, Fault warning-Green light flashes
- ② Camera
- ③ Microphones hole
- ④ Bracket for expose installation
- ⑤ Cable
- ⑥ **Setting button: Used for working mode switching, NO/NC switching, initialization setting**
- ⑦ SD card socket
- ⑧ Bracket for concealed installation
- ⑨ Screw cover

**Working mode switch:** 1, Press the setting button once, when you hear a beep voice, it will switch to the **"human figure high sensitivity"** mode (high-sensitivity induction, suitable for applications that require both motion and presence safety functions. )(Factory default setting)  
 2, Press the setting button again, when you hear two beep voice, it will switch to the **"human figure medium sensitivity"** mode (normal induction, suitable for scenes with slight disturbance on site.)  
 3, Press the setting button again, when you hear three beep voice, it will switch to the **"human figure low sensitivity"** mode (suitable for scenes that only sense the human figures)  
 4, Press the setting button again, when you hear four beep voice, it will switch to the **"only movement"** mode (suitable for scenes that all movement are sensed)

**NO/NC switch:**  
 1, Cut off the power, press and hold the setting button, power up again, when you hear a beep voice, it will output NO signal (Factory default setting)  
 2, Cut off the power, press and hold the setting button, power up again, when you hear two beep voice, it will output OC signal.

**Initialization setting:** Press and hold the setting button, when you hear a long beep voice, release the button, then after 3 sets "beep-beep" voice, system initialization is successful.

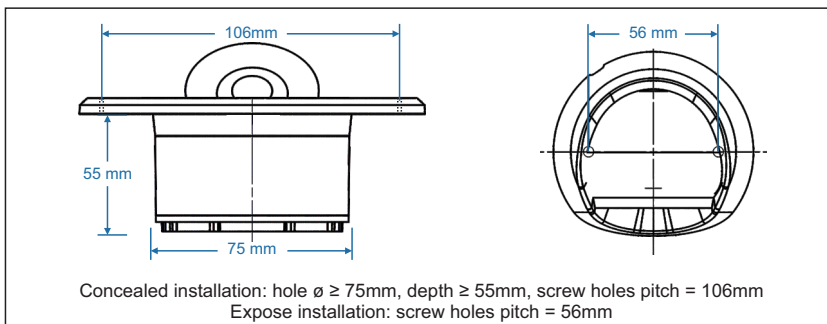

▲ Installation hole size

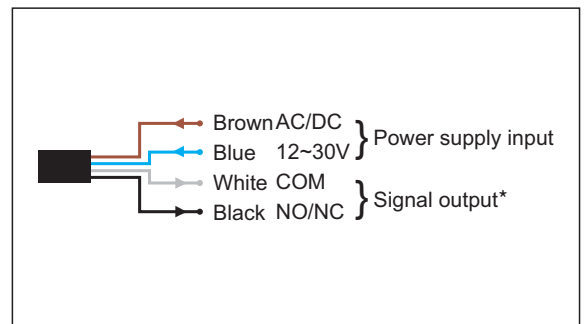

▲ Wiring diagram

### 3 Function features

- 1, Recognizing the human figure in the detecting area, whether in the moving or stationary state, it can also outout signals. This product can be as a motion sensor, also as a presence safety sensor.
- 2, Adopt advanced Convolutional Neural Network, to detect and recognize the human figure, can avoid interference from strong light, vibration, flying insects, floating leaves, etc.
- 3, It supports inserting an SD card and expanding the memory to 128G to realize all-day video monitoring; and it is convenient for users to upgrade the system without changing the hardware.
- 4, Equipped with the global AI+LOT Internet of Things platform--"TUYA", the detecting area size can be set through the APP, and remote monitoring and remote opening of the door can be realized by mobile phones.
- 5, Built-in microphone, real-time simultaneous monitoring.
- 6, Four working mode can be switched freely, which is convenient to adapt to various use occasions.

## 4 Installation methods and precautions

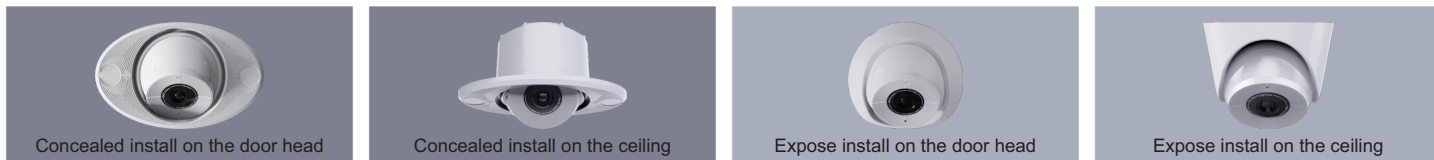

1, Four installation methods, flexible to choose and suitable for all kinds of occasions.

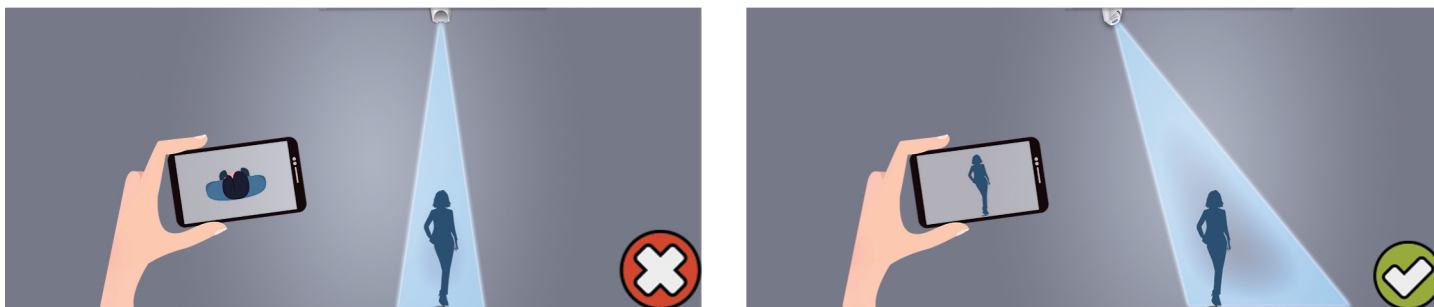

2, Due to the human figure judgment, please ensure a certain shooting angle of camera when installation, The directly top overlooking view is the most unfavorable for human figure recognition.

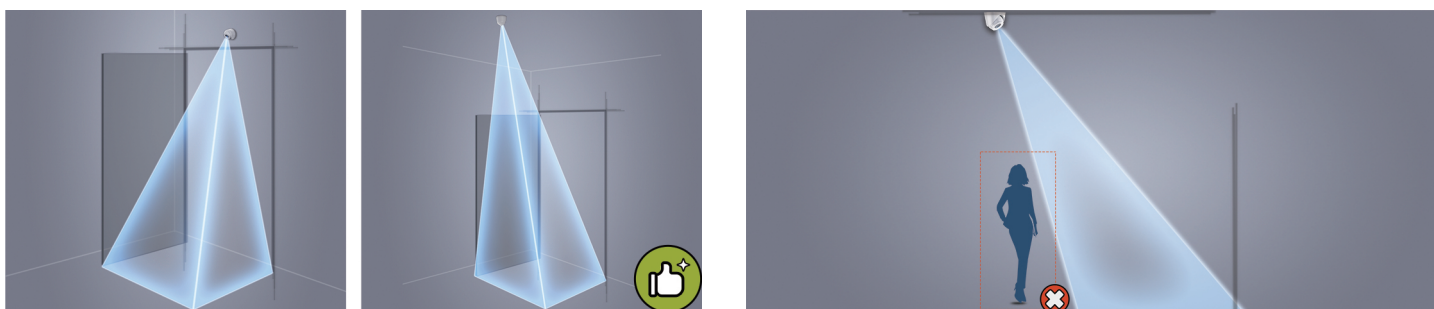

3, In order to better use the human figure detection and recognition function, please give priority to the installation of ceiling and reverse-view type installation, can effectively operate the motion and anti-pinch functions.

4, Below the angle of view is the blind area, the human figures may not be judged in this area.

5, During outdoor installation, strong light will affect network distribution and code scanning. Please install the products outdoor after completing the code scanning and network distribution indoors.

## 5 TUYA APP Setting Process

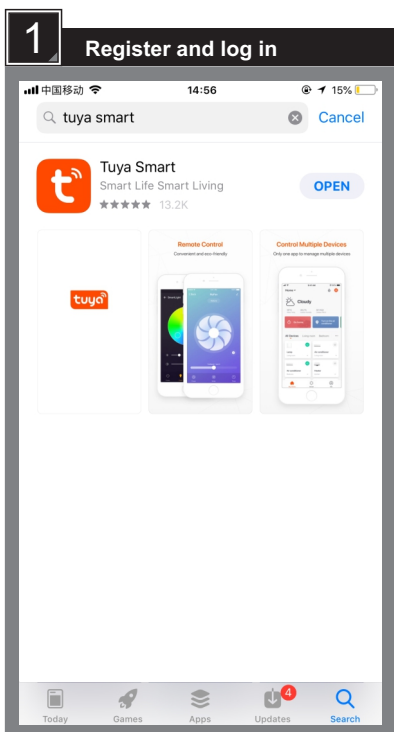

Please search "Tuya Smart" APP in your mobile App market, click "GET" to install.

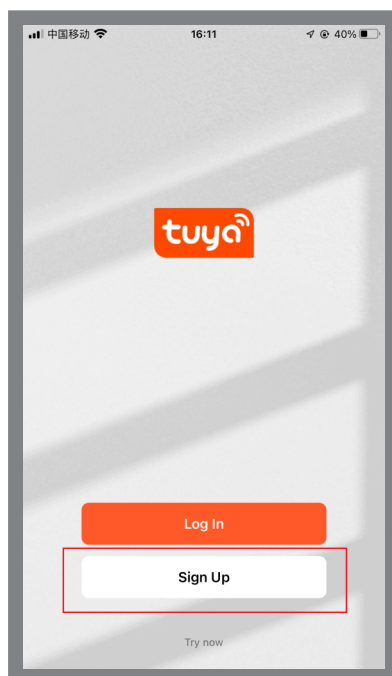

Open this APP, click "Sign Up".

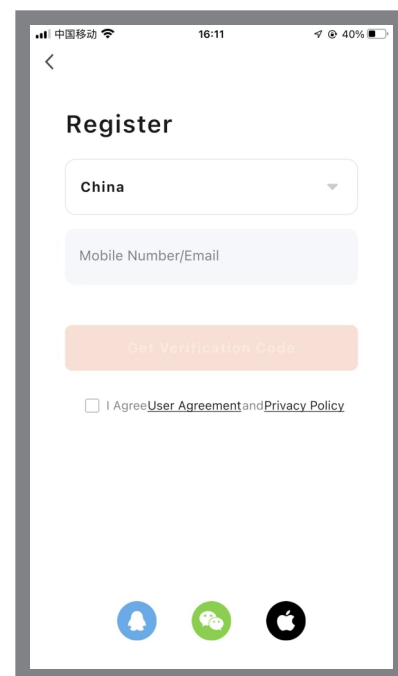

Complete the follow-up registration process according to the relevant prompts on the page.

## 2 Add device network connection

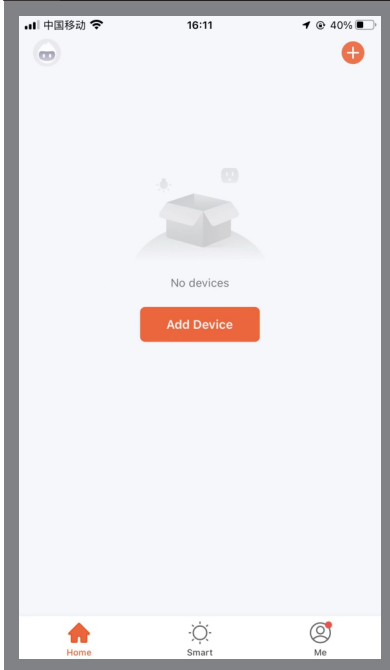

Before adding the device, press and hold the setting button for 3 seconds, release it after hearing a long beep sound, and after 6 beep sounds, the system is initialized successfully. Then click "Add Device".

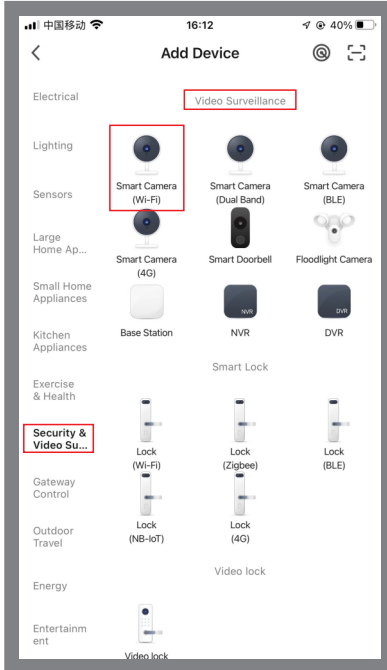

In the "Security & Video Surveillance" category, find the "Video Surveillance" group, select "Smart Camera(Wi-Fi)".

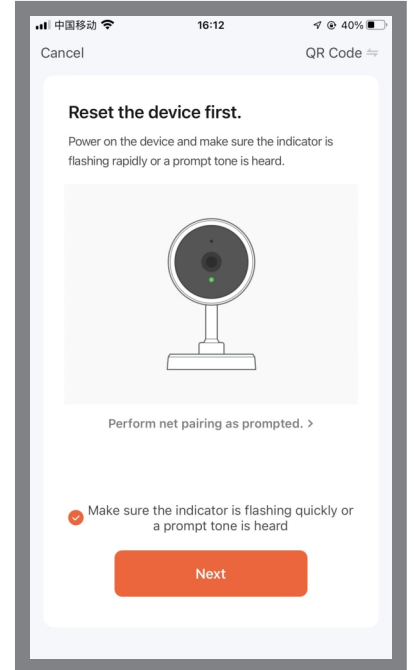

Check "Make sure the indicator is flashing quickly or a prompt tone is heard" and click "Next".

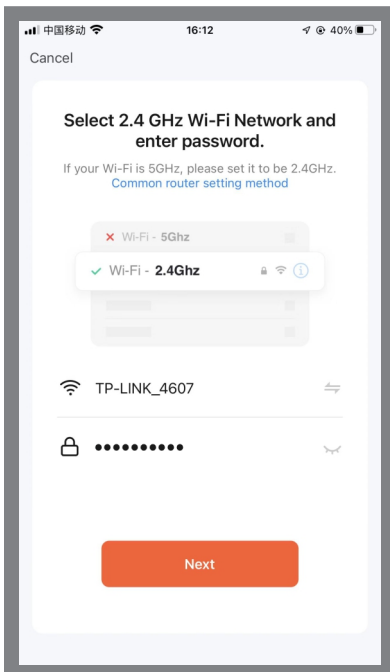

Select the 2.4GHz Wi-Fi network and enter your password, click "Next".



Please scan the QR code by camera, after hearing a beep sounds, click "Heard a prompt".

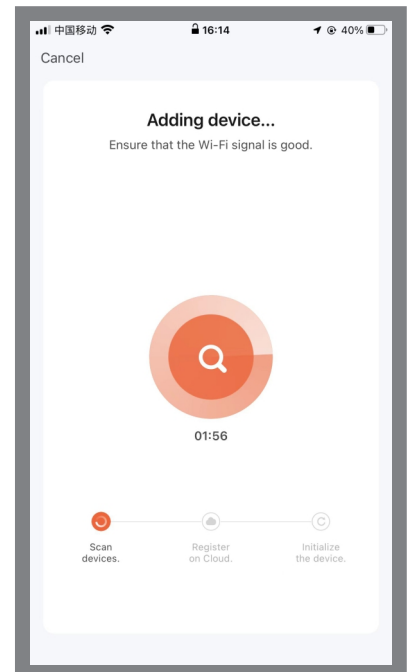

Wait for the network connection to pair.



If you need to change the device name, you can click the "✎" icon, click "done".

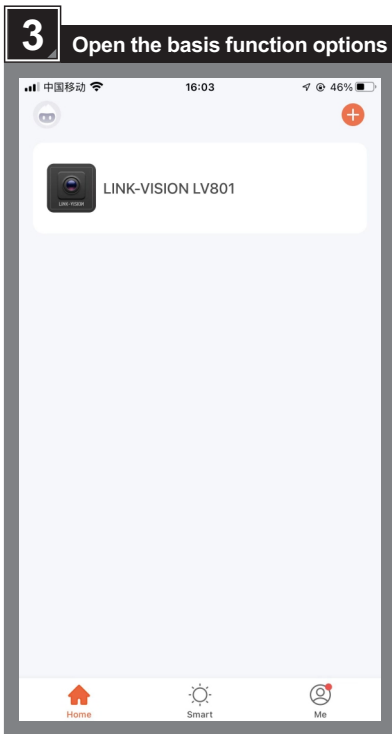

Click the added device, entering the real-time monitoring

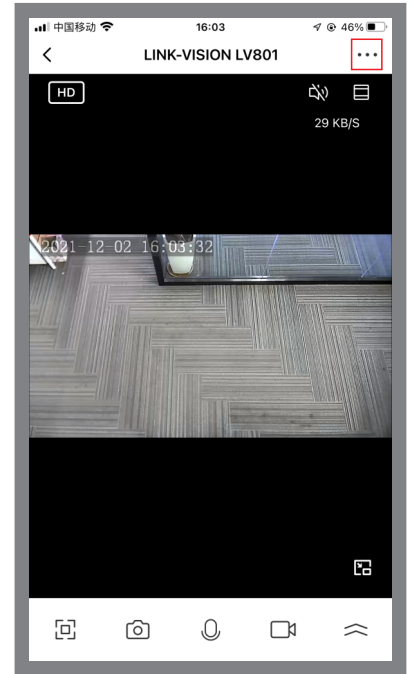

Click the "⋮" icon on the upper right of screen to enter the system setting interface.

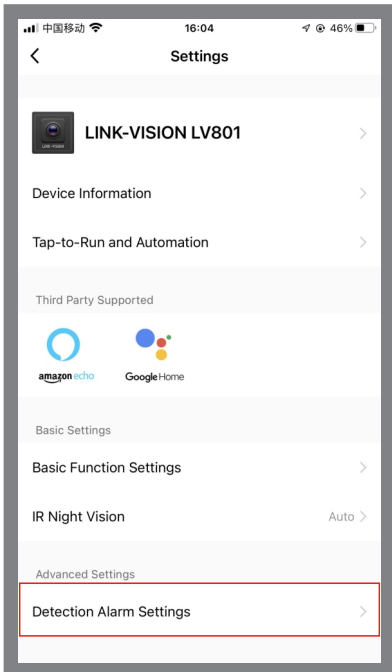

Click "Detection alarm Settings"

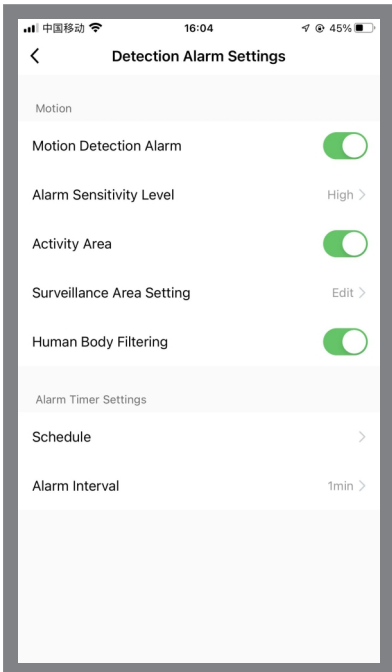

Open the basis function options

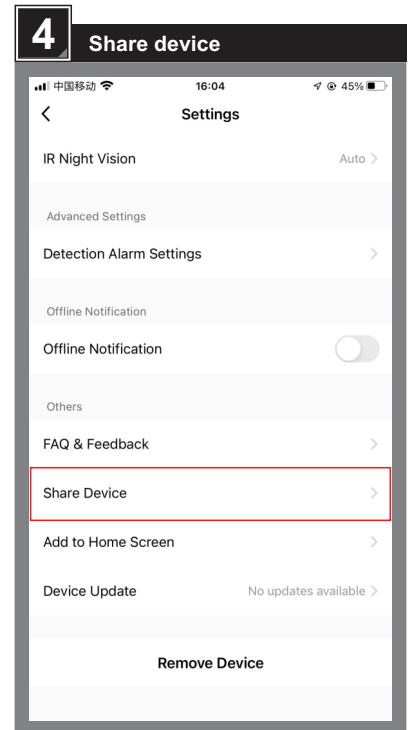

Return to the system setting interface, click "Share device", can share the current device to other users

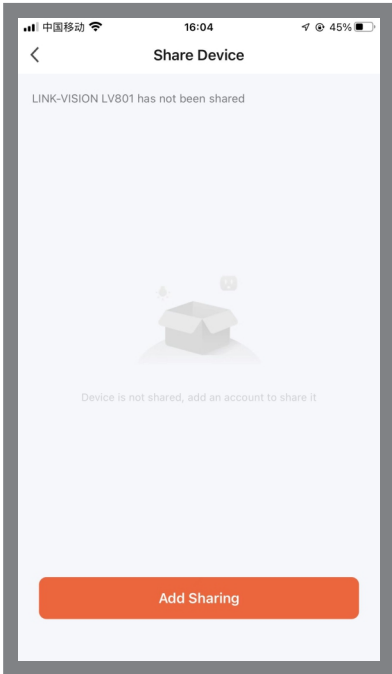

Click "Add sharing"

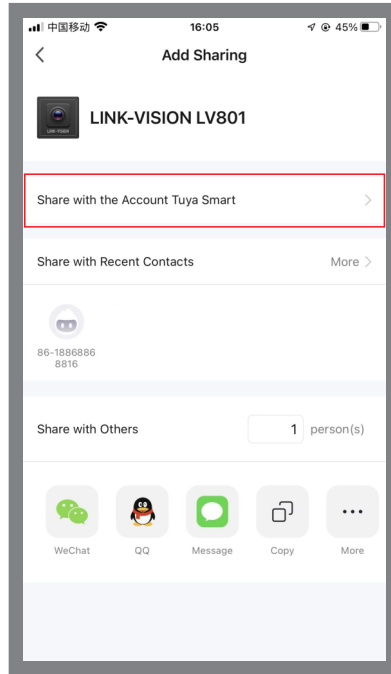

Click "Share with the TUYA Smart account"

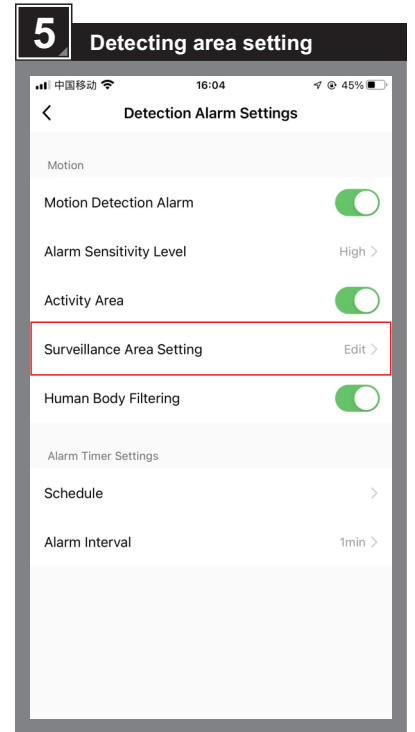

In the detection alarm setting interface, click "Surveillance area setting"



Slide or expand the red selection area with your finger to adjust the detection area, then click "save"

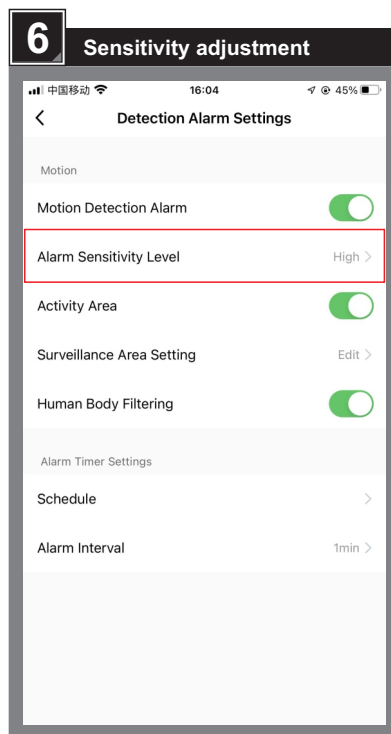

In the detection alarm setting interface, click "Alarm sensitivity level" to choose "High, middle, low" three sensitivity, adapt to all kinds of occasions.

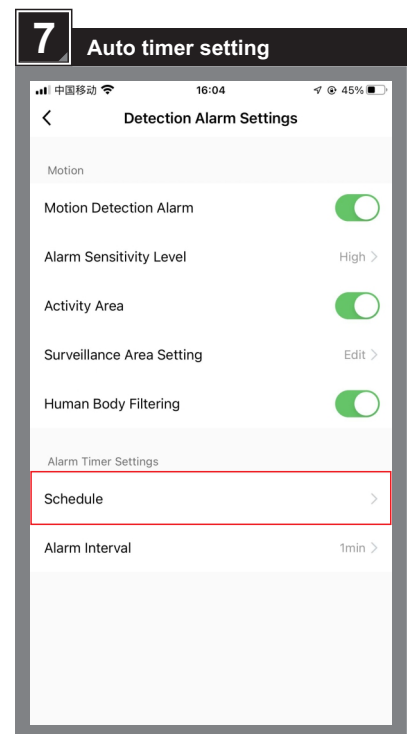

In the detection alarm setting interface, click "Schedule" function below the "Alarm timer settings"

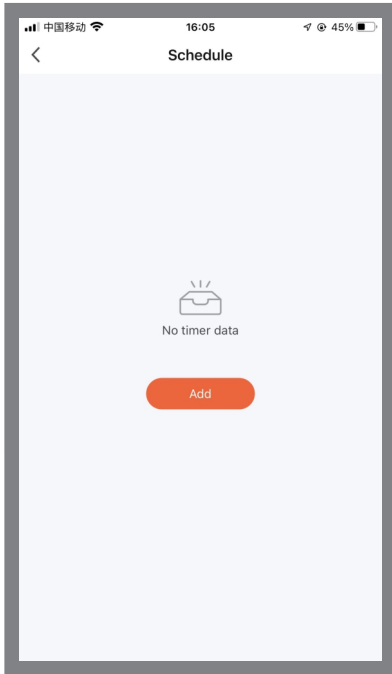

Click "Add"

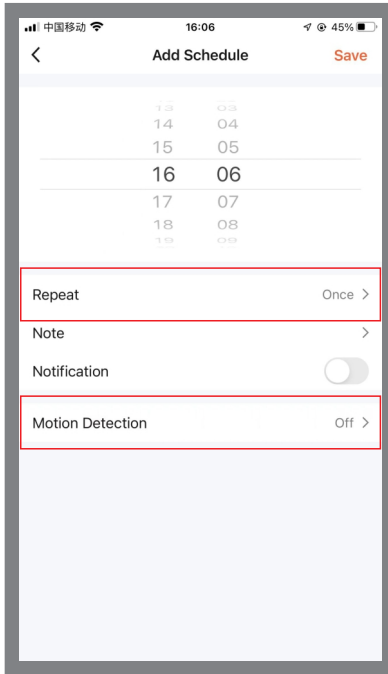

Choose the ON/OFF time, click "Motion detection" for setting, and click "Repeat"

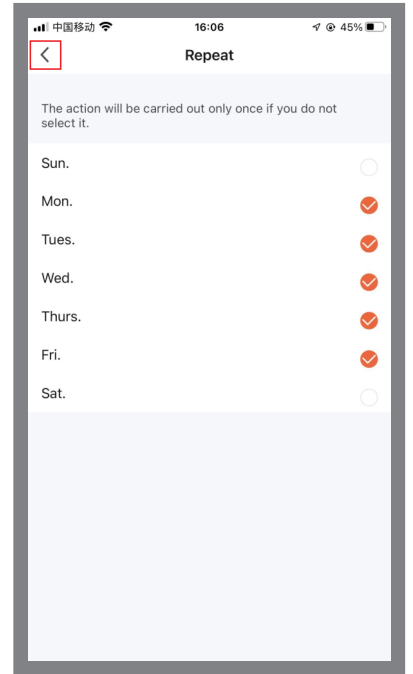

Set the repeat schedule (Such as: working day or off day etc), complete setting and back to last interface

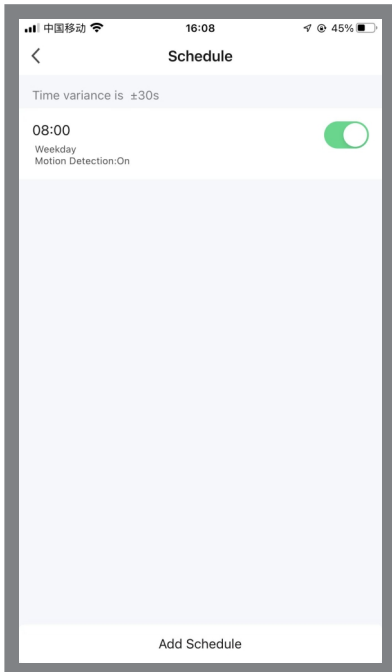

Click "Save", add successfully.

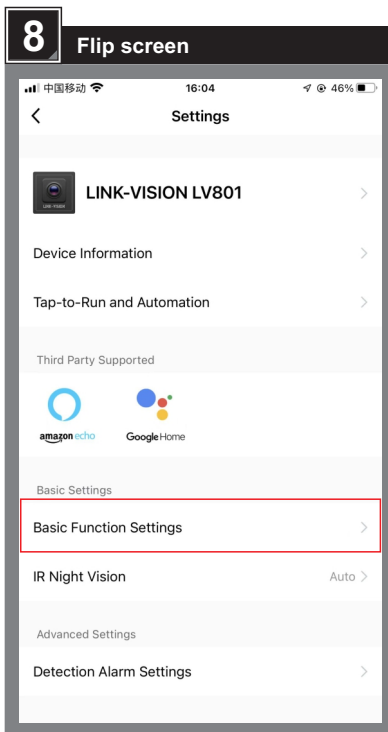

Return to the system setting interface, click "Basic function settings"

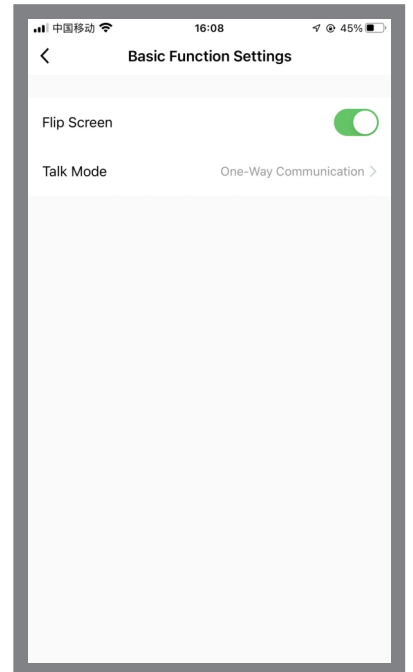

Sometimes, different installation methods may cause the video screen on the mobile phone to be inverted. In this case, click "Flip screen"

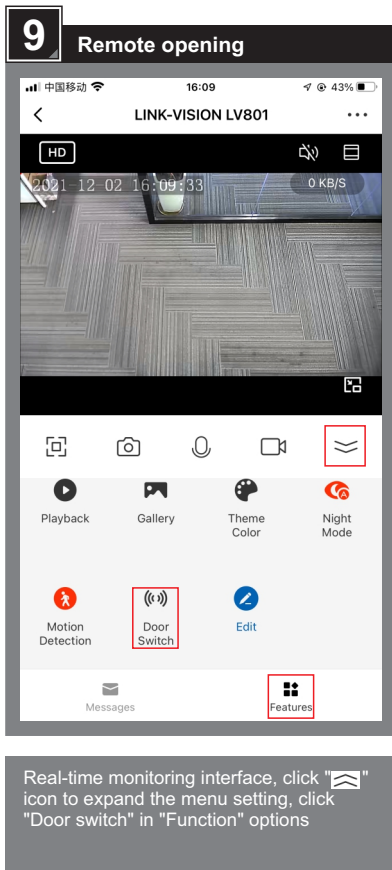

Real-time monitoring interface, click "≡" icon to expand the menu setting, click "Door switch" in "Function" options

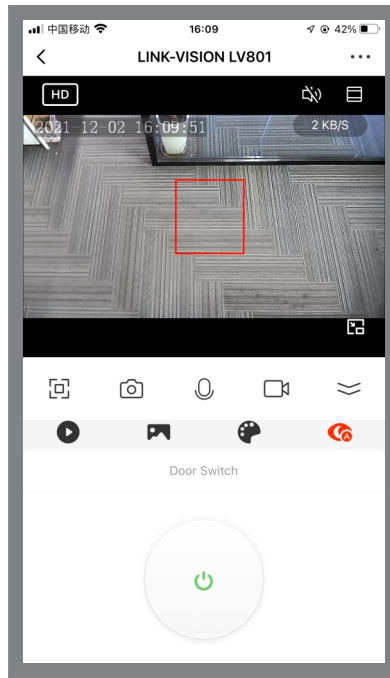

Click button and it will turn to green, and the red selection area in the center of the screen will flash, remote open the door successfully.

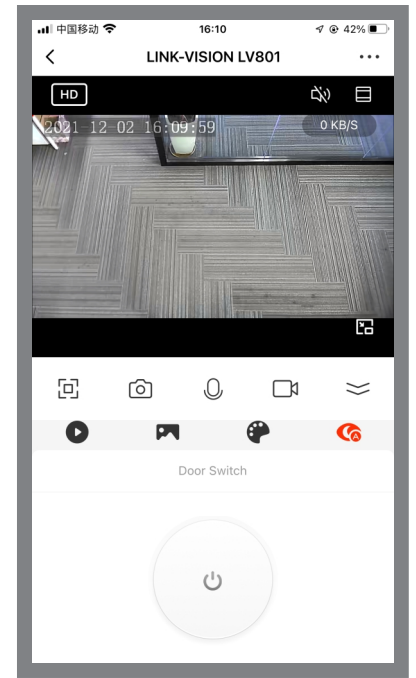

Click the button again, it will turn to grey, and without red selection area, remote close the door successfully.

## 6 Troubleshooting

| Symptoms   | Cause  | Methods  |
|--|--|--|
| LED indicator light off  | The sensor is not connected to power supply    | Check the cable connection, and whether power supply is normal   |
| Blue indicator is on, but can't sensing to open the door                                   | 1, The sensor is not registered and authorized | 1, Register sensor online  |
|  | 2, Detection alarm function is not enabled     | 2, Turn on the human figure filter switch of the mobile detection alarm switch in the "Detection alarm setting" on the phone App |
|  | 3, Not at the set opening time                 | 3, Reset the opening time  |
| Blue indicator is on, and door in NO state, door is closed after sensing and Red indicator | NO/NC signal is incorrect                      | NO/NC mode switch through setting button   |
| Video screen is inverted   | Different installation methods caused          | Turn on/off the "Flip screen" function in the "Basis function setting" on the phone App  |
| Green light flashes once   | SD card fault                                  | 1, Format SD card, or replace a new SD card. 2, Use a new SD card less than 128G   |
| Green light flashes twice  | Sensor failure                                 | Restart the sensor or replace a new sensor if still not work.  |
| 1, Low sensitivity induction;<br>2, False trigger due to objects movement                  | Working mode is inappropriate.                 | Switch to the appropriate working mode by setting button   |
| Closing delay time after too long  | There are floating object around               | 1, Mark the floating object out of the detection area. 2, Remove the floating object   |



Due to the limitations of AI Neural Network deep learning, in some special scenes, the system will output certain confidence for some non-human figure objects (similar human figure), and it is possible to output signal. Please try to solve the problem by the following methods: 1, Rotate the position of the objects, may not be recognized as a human figure. 2, Reduce the sensitivity. 3, Adjust the lens angle of camera or adjust the detection selection area, so as to avoid the object appearing in the screen.

## 7 Technical parameter

|                   |  |                       |   |
|-------------------|--|-----------------------|---|
| Main processor:   | INGENIC T31N   | Detection function:   | human figure motion, presence, remote control opening, monitoring, Time setting function, Infrared night vision |
| Main frequency:   | 1.5GHz   | Signal output:        | Relay NO, NC optional   |
| Detection mode:   | Moving + human figure detection (Dual mode)                  | Power supply:         | AC/DC 12-30V  |
| Pixel:            | 1080P(HD) 1600*1200  | Standby consumption:  | 230mA(DC12V power)  |
| Response speed:   | 50ms   | Working current:      | 280mA(DC12V power)  |
| Monitor storage:  | TF card in FAT32 format, maximum 128GB memory                | Installation methods: | Expose or embedded installation on the door head, wall, and ceiling   |
| View adjustment:  | 0-90° (expose installation)<br>0-45° (embedded installation) | External dimension:   | 86x80x69mm(expose)<br>130x82x71mm(embedded)   |
| Network distance: | 10-30 meters<br>(dependin on the strength of Wi-Fi on site)  | Installation height:  | ≤ 6 meters  |

## 8 Packing List

| ITEM                               | PCS | REMARK                        |
|------------------------------------|-----|-------------------------------|
| Sensor                             | 1   |                               |
| Bracket for expose installation    | 1   | Bracket, cover                |
| Bracket for concealed installation | 1   | Bracket, cover, screw cover*2 |

| ITEM                      | PCS | REMARK                  |
|---------------------------|-----|-------------------------|
| Four-core buckle cable    | 1   | 2.5 meters              |
| Screws bag                | 1   | Screws*2, rubber plug*2 |
| Installation instructions | 1   |                         |